

Product designation				Power contactor
Product type designation				DPBF80
<b>Contact characteristics</b>				
Number of poles		Nr.	3	
Operational frequency		min	Hz	25
		max	Hz	400
<b>Mechanical features</b>				
Operating position		normal allowable	Vertical plan ±30°	
Fixing				Screw / DIN rail 35mm
Weight		g	1020	
<b>Operations</b>				
Mechanical life		cycles	15000000	
Electrical life		cycles	1300000	
<b>Safety related data</b>				
Performance level B10d according to EN/ISO 13489-1		rated load mechanical load	cycles	1300000
			cycles	15000000
Mirror contacts according to IEC/EN 60947-4-1				yes
EMC compatibility				yes
<b>AC coil operating</b>				
Rated AC voltage at 60Hz		V	24	
AC operating voltage	of 60Hz coil powered at 60Hz			
		pick-up		
		min	%Us	80
		max	%Us	110
	drop-out			
		min	%Us	20
		max	%Us	55
AC average coil consumption at 20°C	of 60Hz coil powered at 60Hz			
		in-rush	VA	210
		holding	VA	15
Dissipation at holding =20°C 50Hz		W	5	
<b>Max cycles frequency</b>				
Mechanical operation				cycles/h 3600
<b>Operating times</b>				
Average time for Us control	in AC			
	Closing NO	min	ms	12
		max	ms	28
	Opening NO	min	ms	8
		max	ms	22
	Closing NC	min	ms	0
		max	ms	0
	Opening NC			

		min	ms	0
in DC	Closing NO	min	ms	40
		max	ms	85
	Opening NO	min	ms	20
		max	ms	55

**UL technical data**

Full-load current (FLA) for three-phase AC motor

at 600V    A    80

General USE

Contactor

AC current    A    115

Short-circuit protection fuse, 600V

High fault

Short circuit current    kA    100

Fuse rating    A    200

Fuse class    J

Standard fault

Short circuit current    kA    10

Fuse rating    A    200

Fuse class    RK5

**Ambient conditions**

Temperature

Operating temperature

min    °C    -50

max    °C    70

Storage temperature

min    °C    -60

max    °C    80

Max altitude

m    3000

**Resistance & Protection**

Pollution degree

3

**Dimensions**

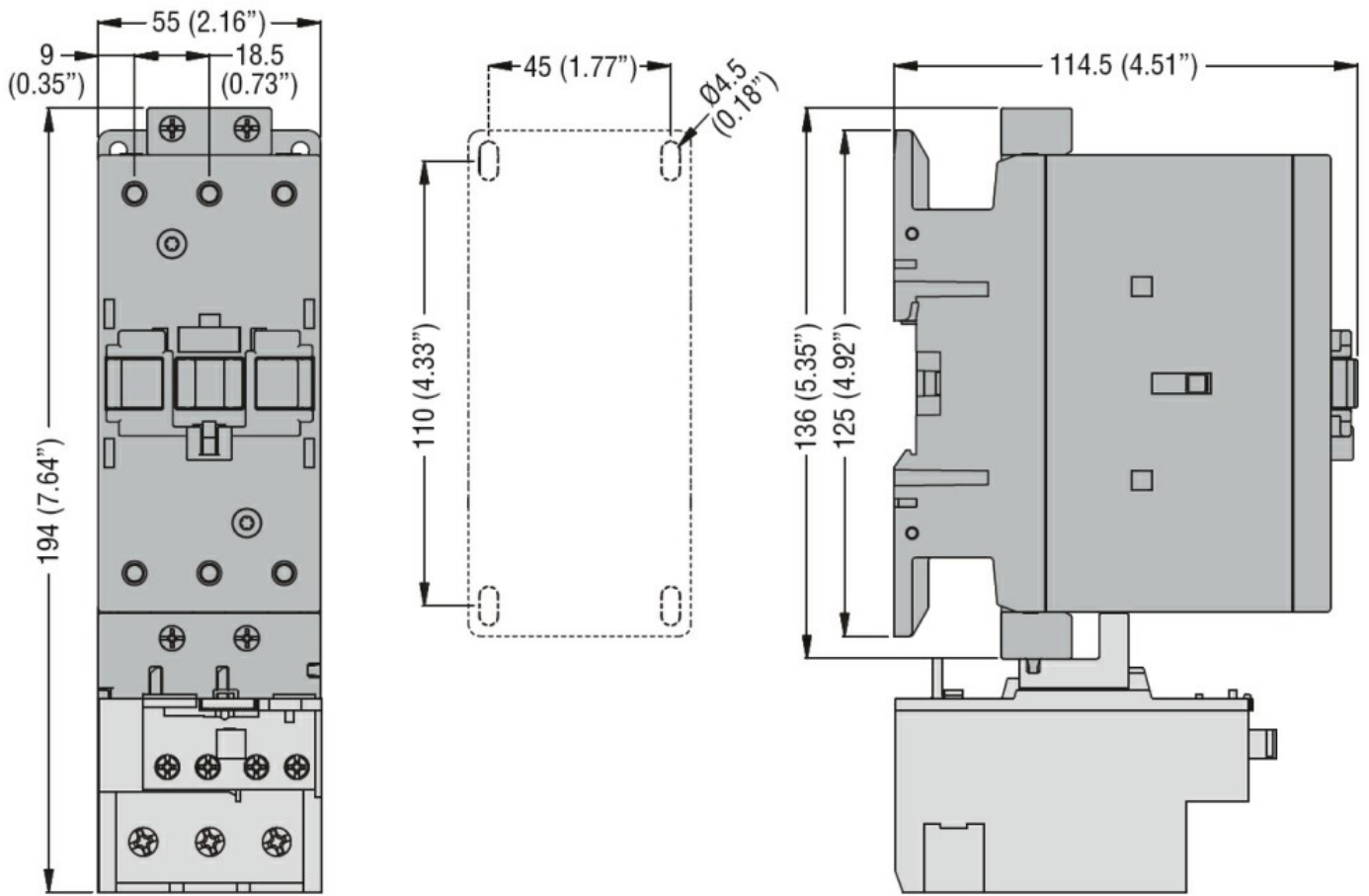

### Wiring diagrams

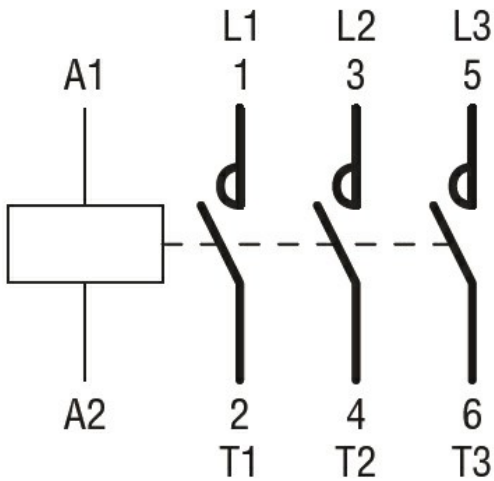

### Certifications and compliance

#### Compliance

CSA C22.2 n° 60947-1  
 CSA C22.2 n° 60947-4-67  
 UL 60947-1  
 UL 60947-4-1

#### Certificates

cULus

### ETIM classification

ETIM 8.0

EC000066 -  
Power contactor,  
AC switching